

PRODUCT SHEET

Description:

Loose MIC Cylinder #J11, KA#G17, NPL, HCK SISO

Item number:

14.03.802-7

Units	Box	Carton	HS Code	Barcode
Pcs.	50	200	8301600090	
				5704866035477

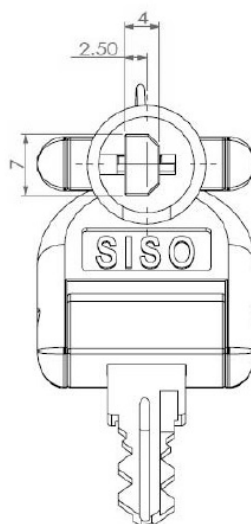
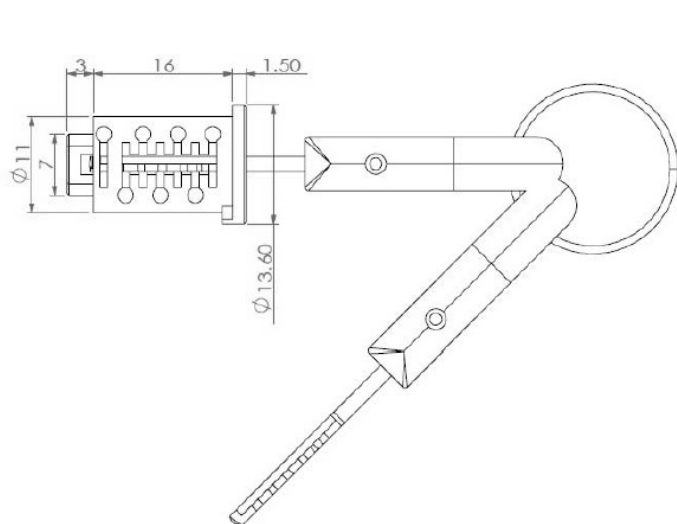

SISO A/S

Mileparken 11
DK-2740 Skovlunde
Denmark
VAT: DK 24786013

Phone +45 45 830 900

www.siso.dk
siso@siso.dk

Danske Bank
Nytorv Branch
Copenhagen
SWIFT: DABADKKK

Account no.
4180 3112 112936
IBAN Account
DK7230003112112936